

(Original) Use and maintenance manual

Type: Splice Presses
Model: EP-220



IMPORTANT:

Read this user manual and follow the instructions and warnings before operating this device.

Any modification or transformation performed on this machine may cause loss of the manufacturer's guarantee and liability.

This manual must always remain near to the machine and visible to all the operating and maintenance staff, for any future consultation, forming part of the equipment.

Index:

	Page
- CE declaration of conformity:	2
- Description of the equipment:	4
- Workshop installation:	4
- Connection of the Control Box:	6
- Equipment identification:	8
- Technical characteristics:	9
- Instructions for use:	10
<i>Preparing the joint:</i>	<i>10</i>
<i>Inflation:</i>	<i>13</i>
<i>Connection:</i>	<i>16</i>
<i>Programming:</i>	<i>17</i>
<i>Connecting the cooling system:</i>	<i>19</i>
- Electrical tradings:	24
<i>3x400V</i>	<i>25</i>
<i>3x230V</i>	<i>26</i>
- Spare parts:	27

CE declaration of conformity:

We ERM Belting Engineering SL. DECLARE, under our responsibility, that the machine:

- Type: Splice press
- Brand: ERM Engineering
- Model: EP-220
- Serial No.: 22541
- Manufacturer date: 2024

Inspired by the directives of the Official Journal of the European Communities:

2006/42/CE Machinery Directive

2014/35/UE Low Voltage Directive

2014/30/UE Electromagnetic Compatibility Directive

Complies with the design and construction specifications of the European Standards on General Machine Safety:

EN 349 - EN 614-1 - EN 614-2 - EN 12100 - EN 11161-1 - EN 1005-1 - EN 1005-2 - EN 1005-3 - EN 1005-4 - EN 13849-1 - EN 13849-2 - EN 894-3 - EN 61310-1 - EN 13732-1 - EN 13850 - EN 13857 - EN 14120 - EN 60204-1

General Manager: Eduardo Ramos Martínez



ermengineering
belting fabrication equipment

Arenys de Munt (Barcelona)-SPAIN

Date: 2024/10

Description of the equipment:

Heating press for fusion welding of conveyor belts, comprised of two aluminium plates with cartridge electric elements, controlled by an external temperature board.

- Pressure by pneumatic cushions to guarantee uniform pressing.
- Intermediate support tray to prepare and hold the joint while hot.
- Interior cooling circuit by water and by air in some models, too.

Workshop installation:

These presses may be used both for in-situ assembly, as well as in fabrication workshops, for which it is recommended to adapt the press to a metallic supporting structure, with pneumatic or counterweighted activation, to open the top plate and adapt the water cooling circuits correctly.



Fig-1

Fig-2

Place the control board on the rack at eye level, safely to avoid it breaking or falling.

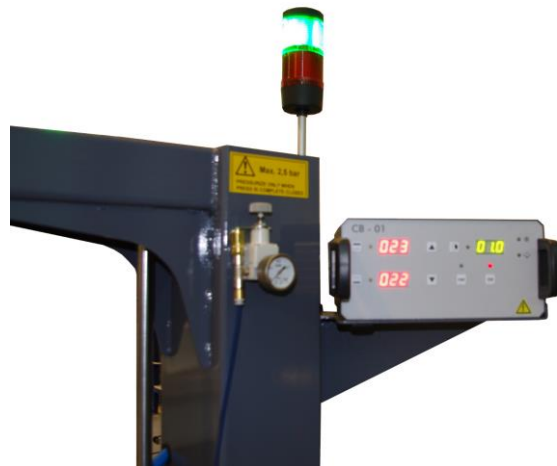

Level the support with the regulation screws located inside the three feet.

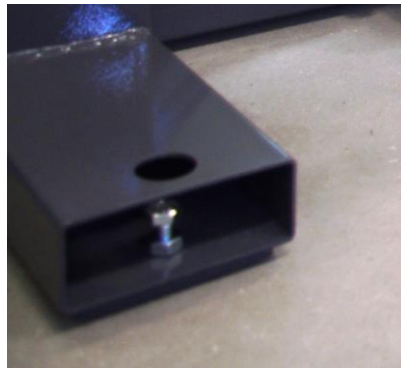

Install the cooling and purge control unit CU-01 on the rear of the support.



Connect the water intake and electric power on the closed side of the support to facilitate extraction of the belt once it has been joined.



NOTE: In the case of several presses being connected to the same drainage line, installation of a one-way valve at each press is recommended, thus avoiding water entering the other presses during the purge process.

Connection of the Control Box:

Before connection to the mains, make sure the rear magneto-thermal lever is down.

- Before connecting the power cable of equipment **H** to the mains, check the voltage recorded on the characteristics plate of the unit, located on the rear label of the board.
- Connect the power cables of press **C** and **D** to the respective top and bottom plates.

NOTE: If we turn on the equipment without the power cables connected to the press, the temperature controls will show a reading error.

Activate the rear lever of the safety magneto-thermal device and its differential switch **B**.

When the equipment is switched on, it will show the values programmed when last used, by default.

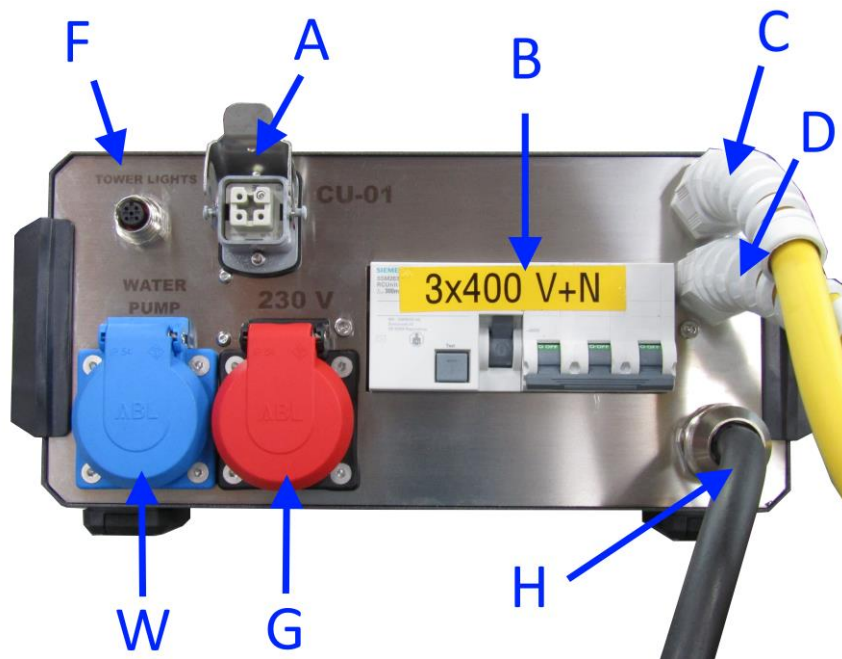

A- Connector of control unit CU-01 Cooling and purge

B- Protection thermal differential

C- Top element connection cable

D- Bottom element connection cable

F- Auxiliary connector for light in frames

G- Socket with permanent voltage 230V

H- Power cable

W- Socket for water pump (automated function)

Equipment identification:

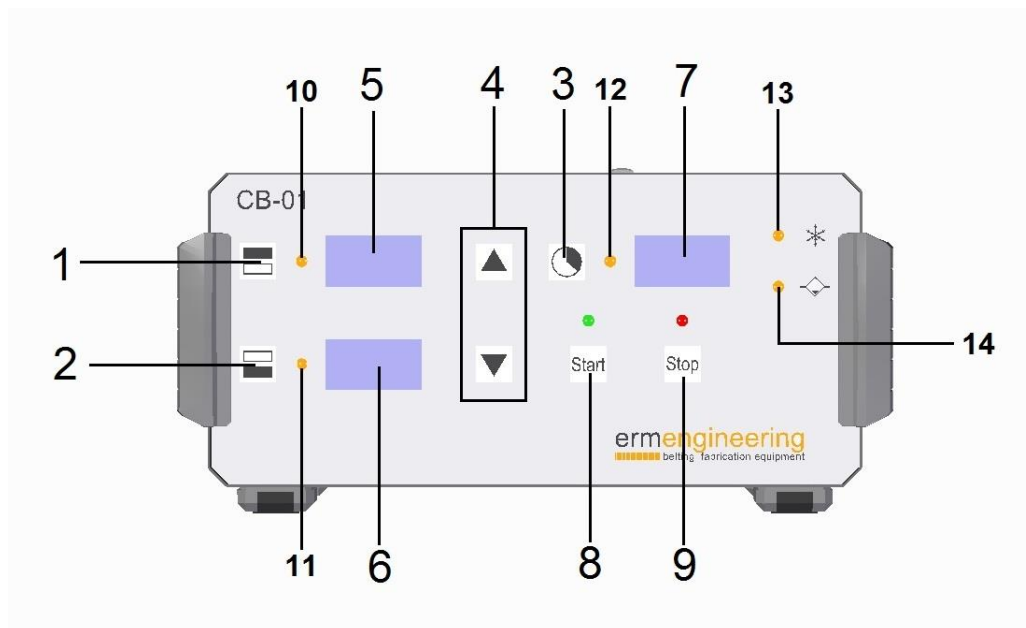

- A- Temperature selection button, top element C°
- B- Temperature selection button, bottom element C°
- C- Welding time selection button
- D- Modify value buttons (increase or decrease)
- E- Top element temperature
- F- Bottom element temperature
- G- Welding time in minutes
- H- Start welding cycle button
- I- Button to halt or stop the process
- J- Power induction marker of the top element
- K- Power induction marker of the top element
- L- Timer start marker
- M- Element cooling process marker
- N- Water circuit purge process marker

NOTE: The 5 and 6 temperature display always show the present temperature of the heating elements. To visualise the value programmed, just press either of the two buttons of each element, 1 and 2.

The display of timer 7 always shows the value programmed in minutes, except when commencing welding time, that will be displayed in countdown mode.

Technical characteristics:

Data press	EP- 220
- Heating area	160x2300mm.
- Dimensions (LxWxH)	2480x360x575mm.
- Upper part weight	68.6 Kg.
- Lower part weight	68.8 Kg.
- Steel plate and clamps weight	34 Kg.
- Total weight	171.4 Kg.
- Power consumption	9660 W
- Electric power supply	3x230//3x400 V + Neutral
- Frequency	50-60Hz
- Compressed air supply	2.5 bar
- Belt thickness max.	12 mm.
- Minimum length belt with steel plate	1080mm.
- Minimum length belt without steel plate	940mm.
- Max. temperature	200° C
- Cooling media.	Water
- Mean heating time at 175°	7 min.
- Water cooling time from 175° to 60°	3.3 min.
- Current	13 A – 3x400V

Instructions for use:

Open the press by releasing and extracting the two closing bolts located at both ends of the top plate.



WARNING:

Before opening the press, check that the inflation pressure of the manometer is 0 bar.

Preparing the joint:

Place the first end of the belt on the lower silicone, well centred on the support tray and making sure the joint is within the welding zone of the bottom plate.

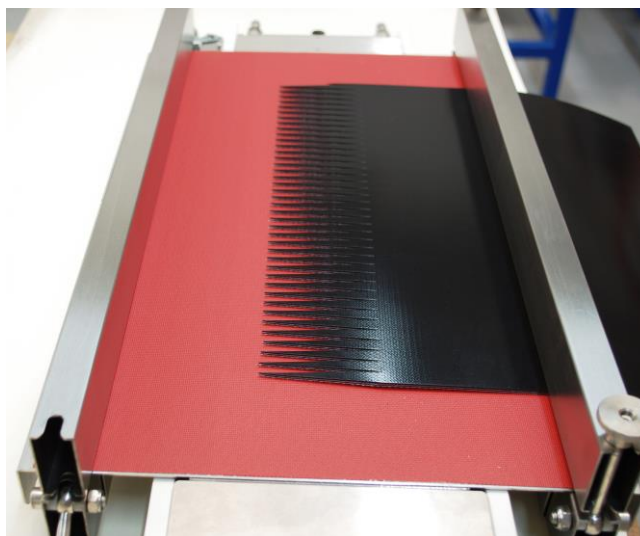

Then place two sufficiently large scraps and the same material offered up to weld, at both ends and properly tangential to the belt, and fix them using the same holding bar. (Fig-3)

It is also possible to use metal callipers of the same thickness as the belt and, when necessary, use scraps of the same belt after the callipers to fill out the welding zone.

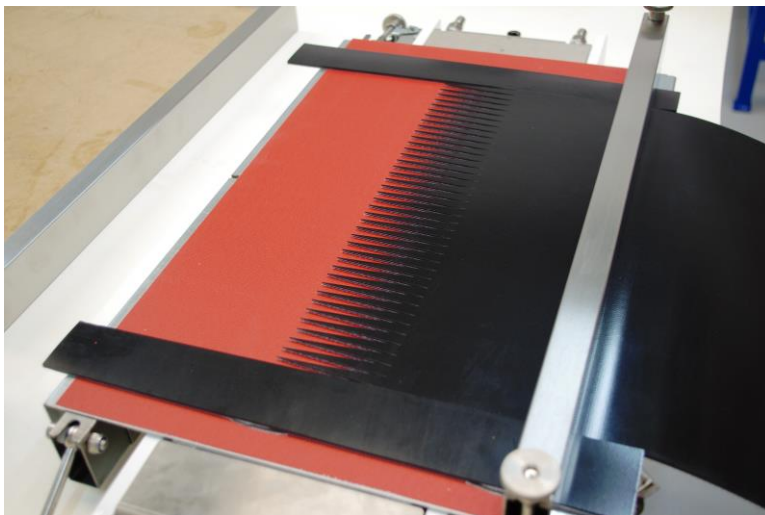
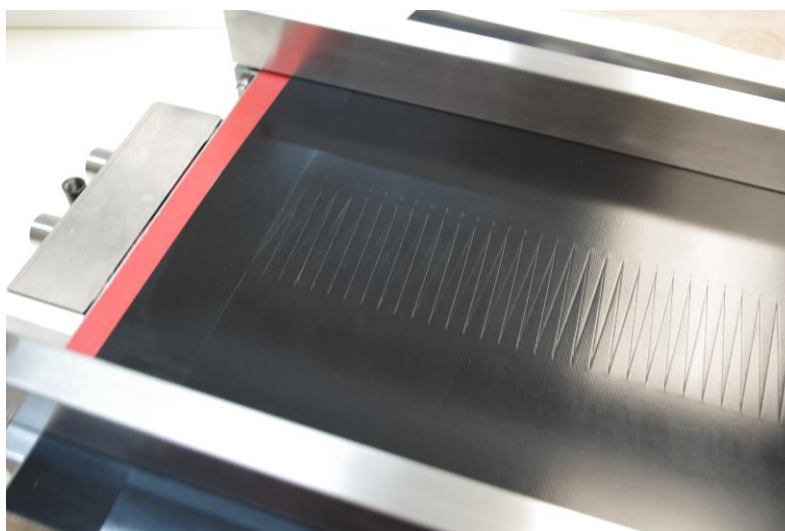

Fig-3

NOTE: It is always recommendable to fill out the material, at least to 70% of the pressing surface, to avoid deformation in the plates or thickness differences in the welding.

Afterward, insert the second end of the belt, leaving the whole surface to be joined fully in contact with the first end already fixed, and hold it with the other holding bar.



Once the joint placement operation has been completed, we cover the whole welding surface with silicone or adequate silicone paper recommended by the belt manufacturer.

So, on completing the welding, we guarantee that the joint zone has the same texture and finish as the rest of the belt.

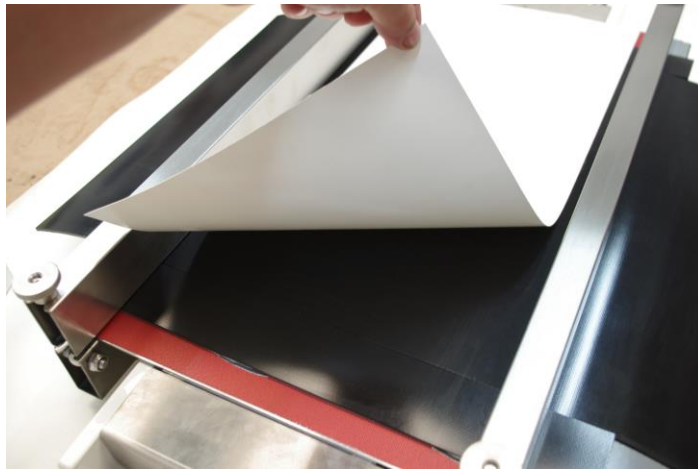

Before closing the press, we place the metal or fibreglass plate, according to the material to be welded, to avoid marks caused by the radical change of temperature and pressure outside the welding zone.

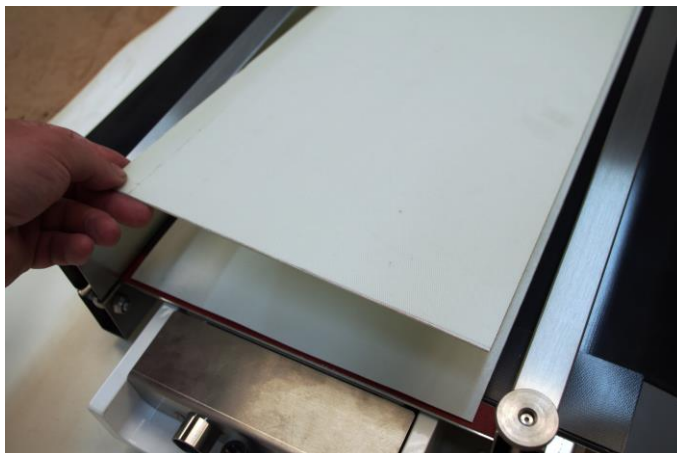

We close the press, centring the upper plate well against the lower one and making sure that the water and electrical connection are at the same end of the press.



Once the upper plate has been put in place, we close the press using the closing controls, softly pressing with just two fingers, and in a balanced way on both sides.

⚠ IMPORTANT: To obtain homogeneous pressure throughout the surface, it is always recommended not to press the closing controls too much, so the pneumatic cushion will thus work in a more balanced way.
The closing screws to close the press must be tighten to the nut minimum 4 turns

Now we can proceed to inflate.

Inflation:

⚠ WARNING:
Always make sure the press is correctly closed before inflating.
There is a risk of explosion of the top plate.

We connect the power socket to on the compressor to the rear red connector on the board, or to another standard 230V. socket:



We then connect the inflation tube to the intake point on the press, simply by pushing it together



NOTE: If the press has a top and bottom cushion, we shall always connect the two sockets. Otherwise, the weld will not be acceptable. If the press only has one top cushion, we will only connect one tube.

We start up the compressor with the switch at position I.



We will control visually the inflation pressure by the manometer of the press, and we will stop the compressor with switch in position "O" once we have achieved the pressure wanted. In case more pressure is needed we can add more with the pressure regulator of the compressor.



WARNING

Never exceed the maximum inflating pressure of the press 2.5 Bar



Once the inflating pressure is finished, we can disconnect the intake air tubes of the press to avoid loss of pressure during welding.



Once the required pressure has been reached, we shall stop the compressor with 0 STOP and disconnect the air tube of the press, moving the ring of the coupling piece inward.

NOTE: If the press has two cushions, we must disconnect both the top and bottom tubes at the same time to prevent air leakage from the cushions. It is always recommended to disconnect the inflation tubes during the welding process to avoid pressure leaks through the valves of compressor.

Connection:

We may now connect the control box.

For it, is recommended to check the voltage on the manufacture plate before connecting it to the grid.



We shall connect the power cables of the press from the control board CB-01 so they coincide with the reference colours.

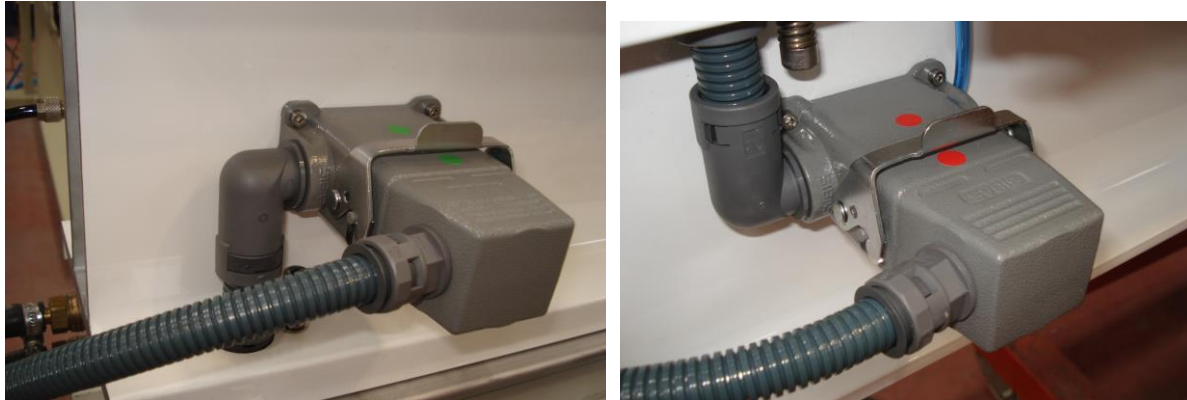

Once the power cables are connected, we raise the lever on the main switch of the board located at the bottom.

Programming:

Now of starting up the board, the actual temperatures of both plates are displayed, and the welding time of the last programming.



To see the temperatures assigned, press the relevant button for each plate.



To program these values, we must hold the button for 3 seconds and change the value using the central arrows to increase or decrease.



The board shall memorise these values, showing the present ones again.

NOTE: The minimum and maximum temperatures that may be programmed are 30 to 200 °C.

We shall perform the same operation to program the welding time, ALWAYS IN MINUTES. The values shown are complete minutes without decimals.



That welding time shall always show the programmed value, except for starting the count, that shall show the count-down until ending.

Once the two temperatures and time values are programmed, we press START.



NOTE: To halt the process or to make any change after beginning with START, we must press STOP and the cycle will stop.

Connecting the cooling system:

This connection of the cooling circuit hoses must be performed before the press reaches the welding temperatures; otherwise, this may lengthen the welding time. To that end, we shall connect the two hoses from the water pump in each of the top and bottom plates, just as shown in the image.

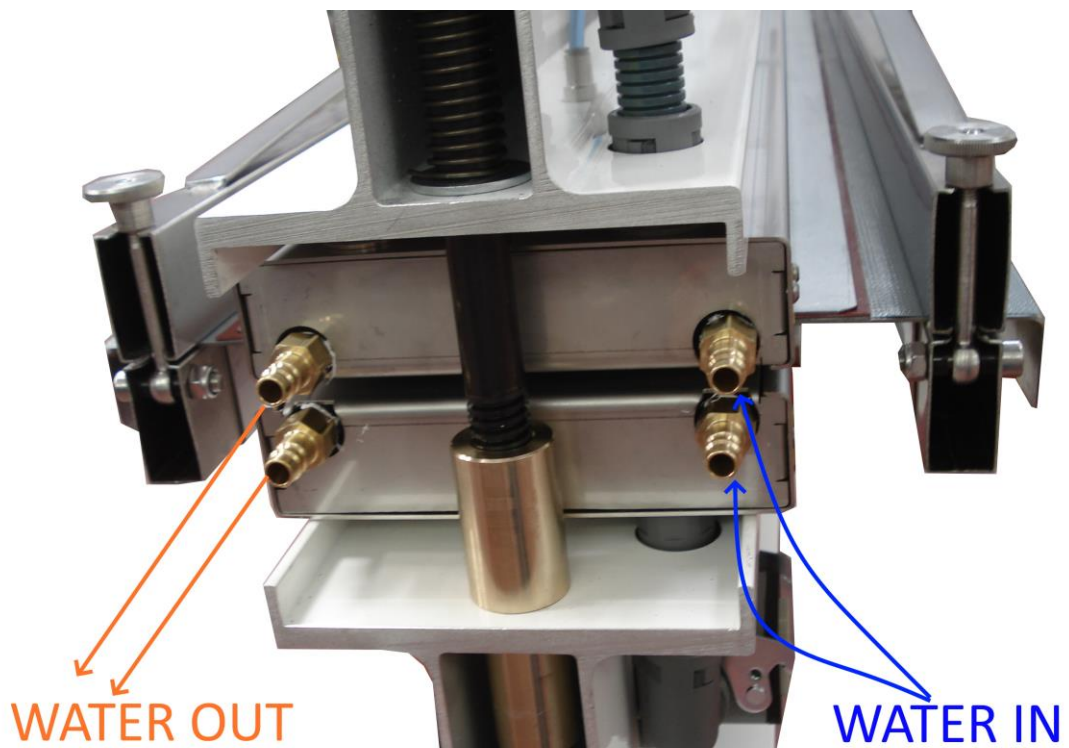

Afterward, we shall connect the two drainage hoses the other two top and bottom conducts.

When the welding time ends, the relevant orange LED to start that operation shall turn on.

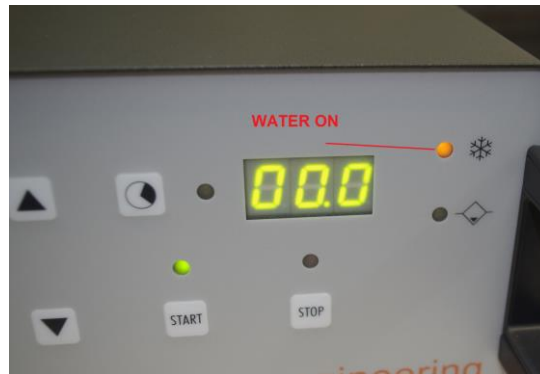

To connect the fast connector, we will move the ring backwards and we will put the racor inside pressing it completely in, in this moment we must move the ring towards the inside to fix closure.

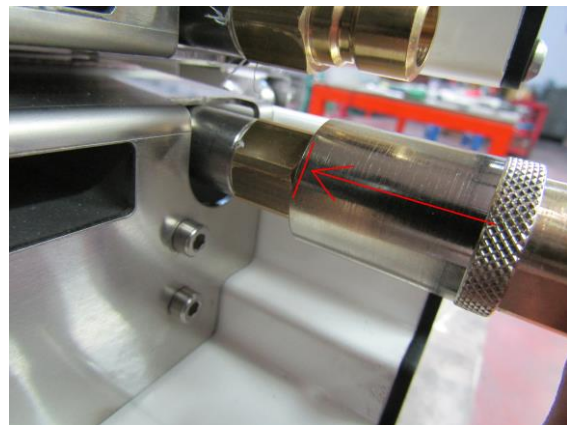
**WARNING:**

Make sure that the four hoses of the cooling circuit are completely connected to their proper connectors. Pull them to assure connection.

If they are not, water steam may go out.

The cooling unit must be connected to the blue socket, which will automatically supply the electric power once the welding process is finished and will stop the cooling operation automatically once the process has finished with the press already cold:



NOTE: We shall not submerge or turn on the water pump until the welding time ends.

We then connect the water pump, or the air blowing unit to cool the equipment, until reaching the temperature of 50 °C when we may stop the cooling.

NOTE: This temperature 50°C can be modified if desired with secret menu.

When the STOP led shows on the board, it means the operation has ended.



IMPORTANT:

After the welding operation, it is essential to purge the water inside the heating plates to avoid temperature differences in next operations.

If we have the control cool unit CU-01 in models FEP with support, the cooling and purge operations are controlled and done automatically by the electro valves of this unit, that must be connected to the rear power supply of the control box and the signal to the connector as shown on the picture.



Once the welding is finished, we will depressurize the press inserting the same air connector. Without putting it all in causing air loss of the circuit, this must be done on both plates of the press.

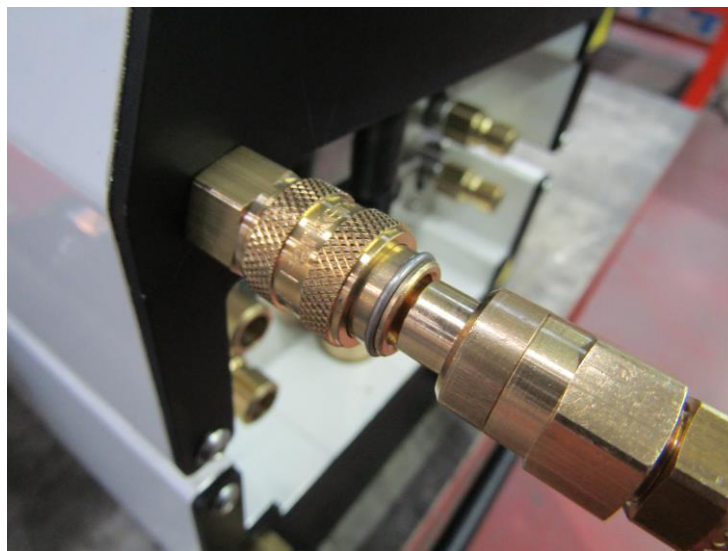

We can then proceed to open it.



IMPORTANT:

Only after having depressurized completely the cushions we can forward to open the press.

Electrical tradings:

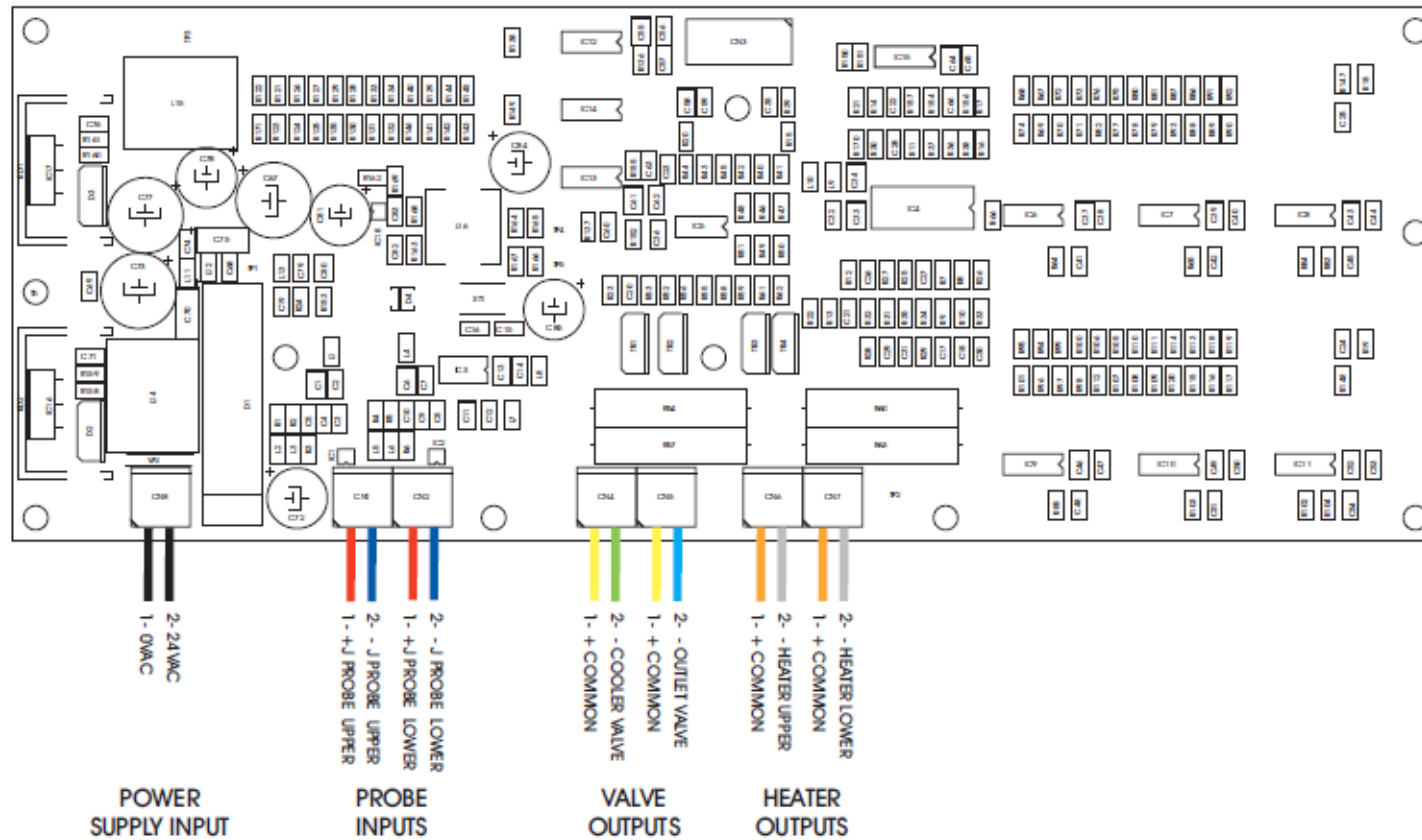

3x400V

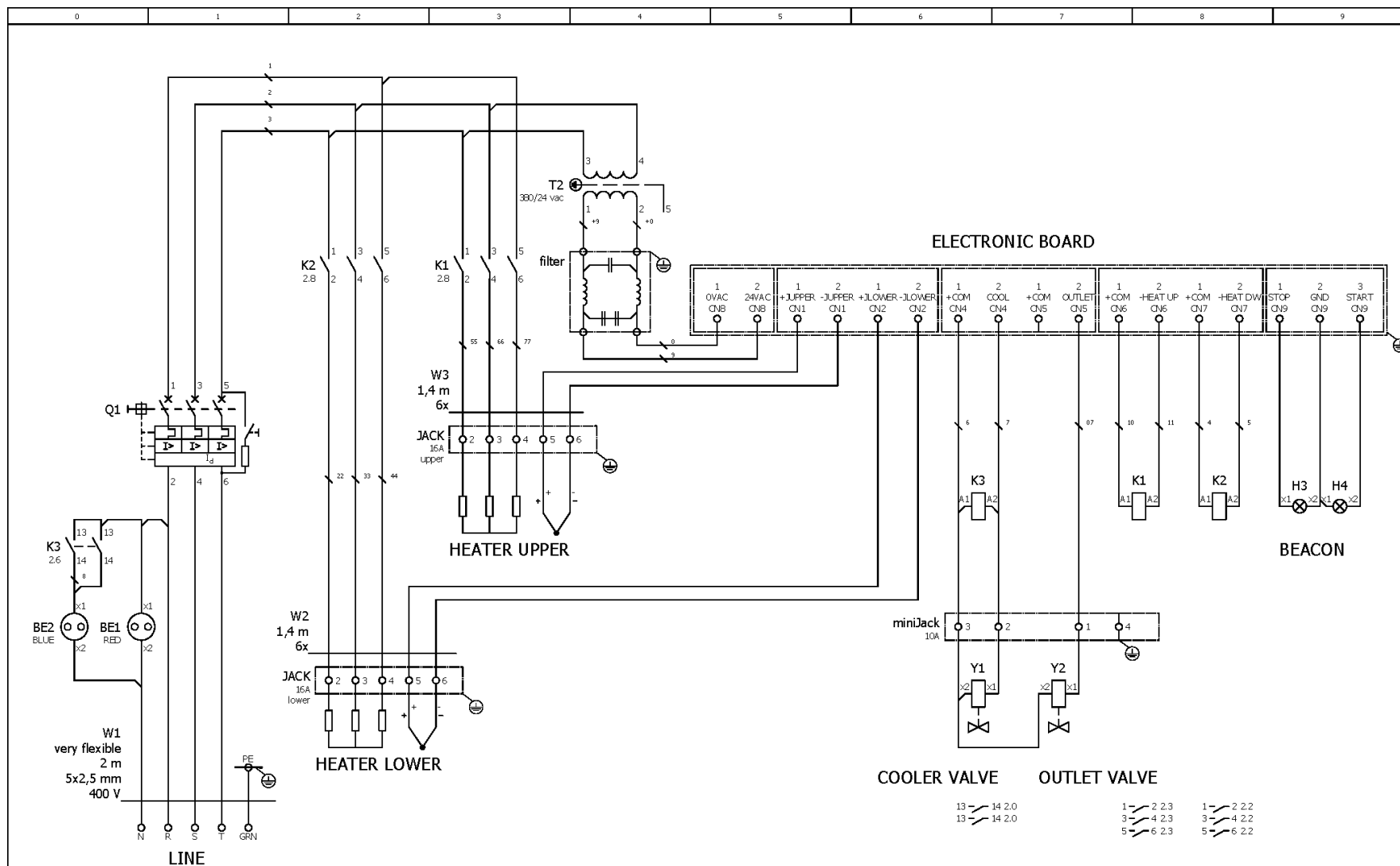

Ciente	Ermengineering	Fecha	17/08/2022
Alimentación	400 ac	Tecnico	Eduardo Viejo
Linea	5x2,5 mm ²	Responsable	Gines Pedrero

HANDLING

Homos Industriales
Proyectos y
Construcciones



CB-01/3 3x400		Departamento Eléctrico	
Nº Fabricación		Tel: +34 938 467 984	
FXXXXX		Page 2	
		Page 2/2	

3x230V.

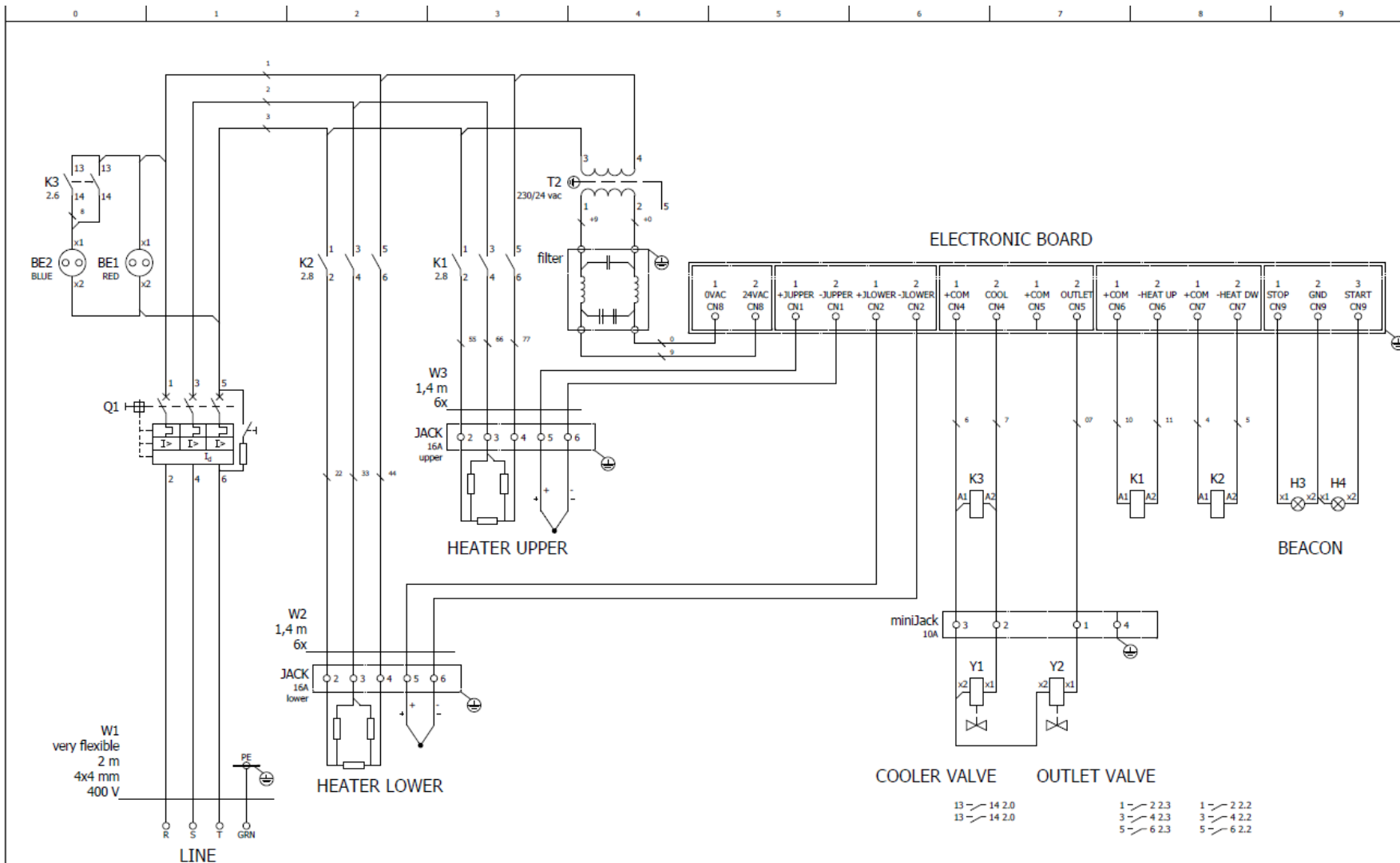

1	Ciente	Emengineering	Fecha	17/08/2022
	Alimentación	400 ac	Tecnico	Eduardo Viejo
	Unia	5x2.5 mm ²	Responsable	Gines Pedrero

HANDLING

Hornos Industriales
Proyectos y
Construcciones



CB-01/2 3x230		Departamento Eléctrico	
		Tel: +34 938 467 984	
Nº Fabricación	FXXXXX	Page	2
		Page	2 / 2

Spare parts:

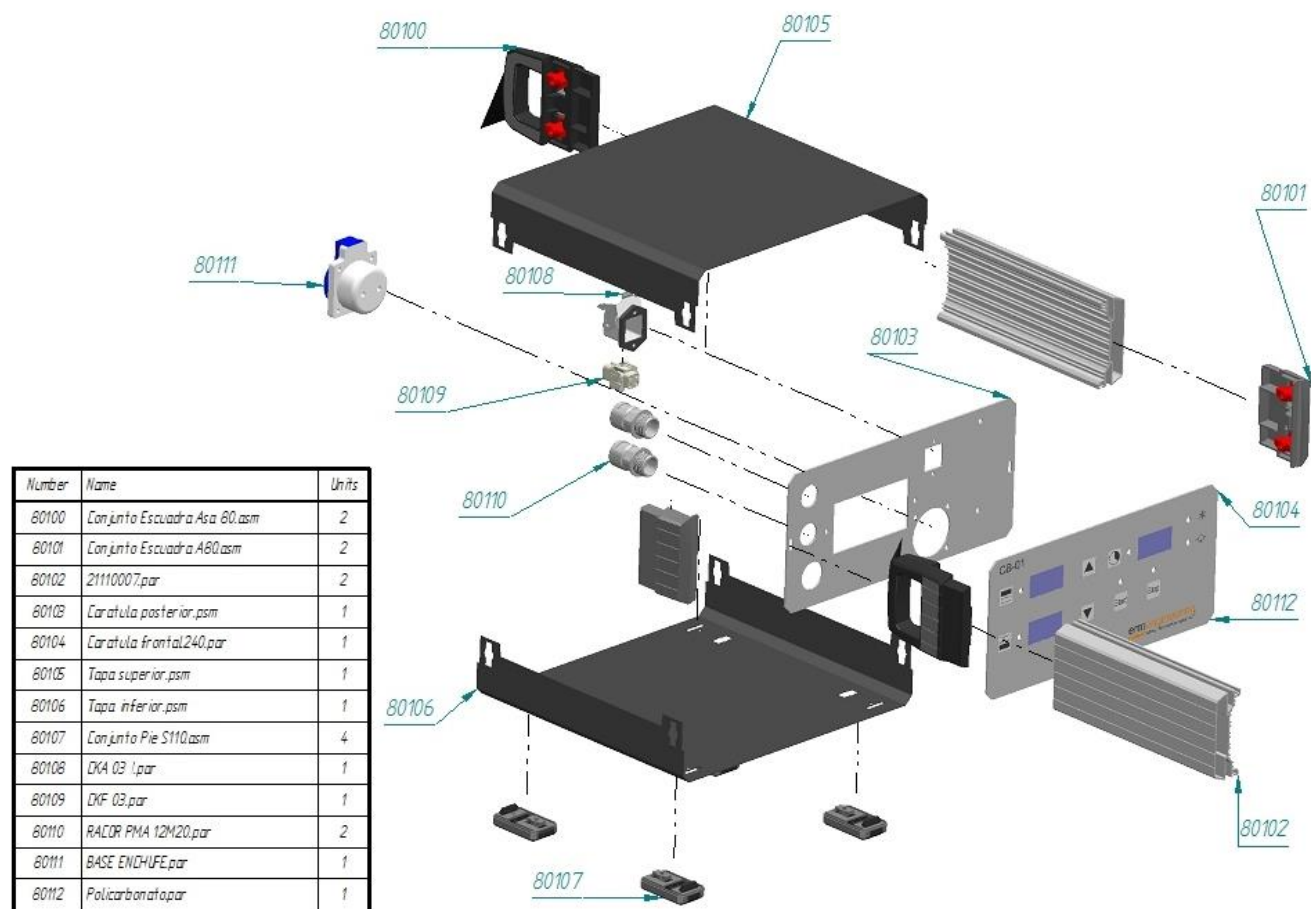

Number	Name	Units
80150	Pieza6.par	1
80151	OMEGA ABB.par	1
80152	Rele 3 fases.par	2
80153	Trafo.par	1
80154	Base contactores.psm	1
80155	Rele 1 fases.par	2
80156	MAG_ABB.asm	1
80157	DIF_ABB.asm	1

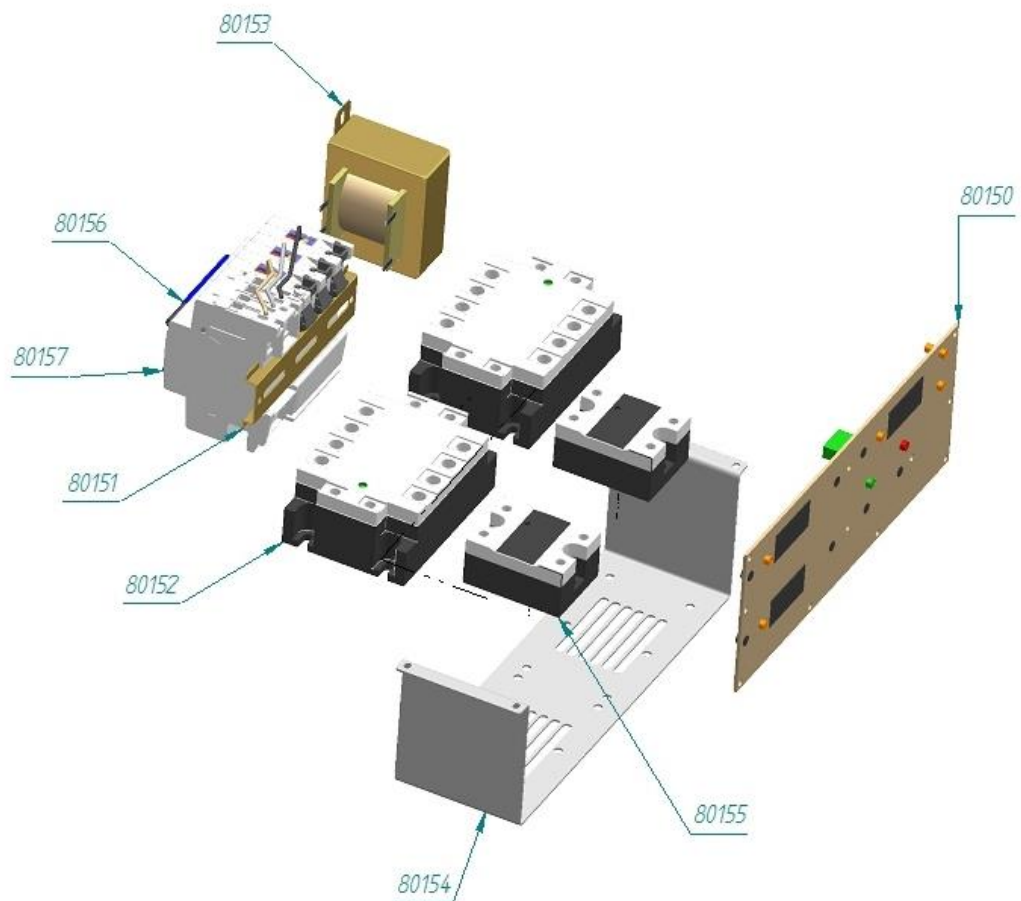

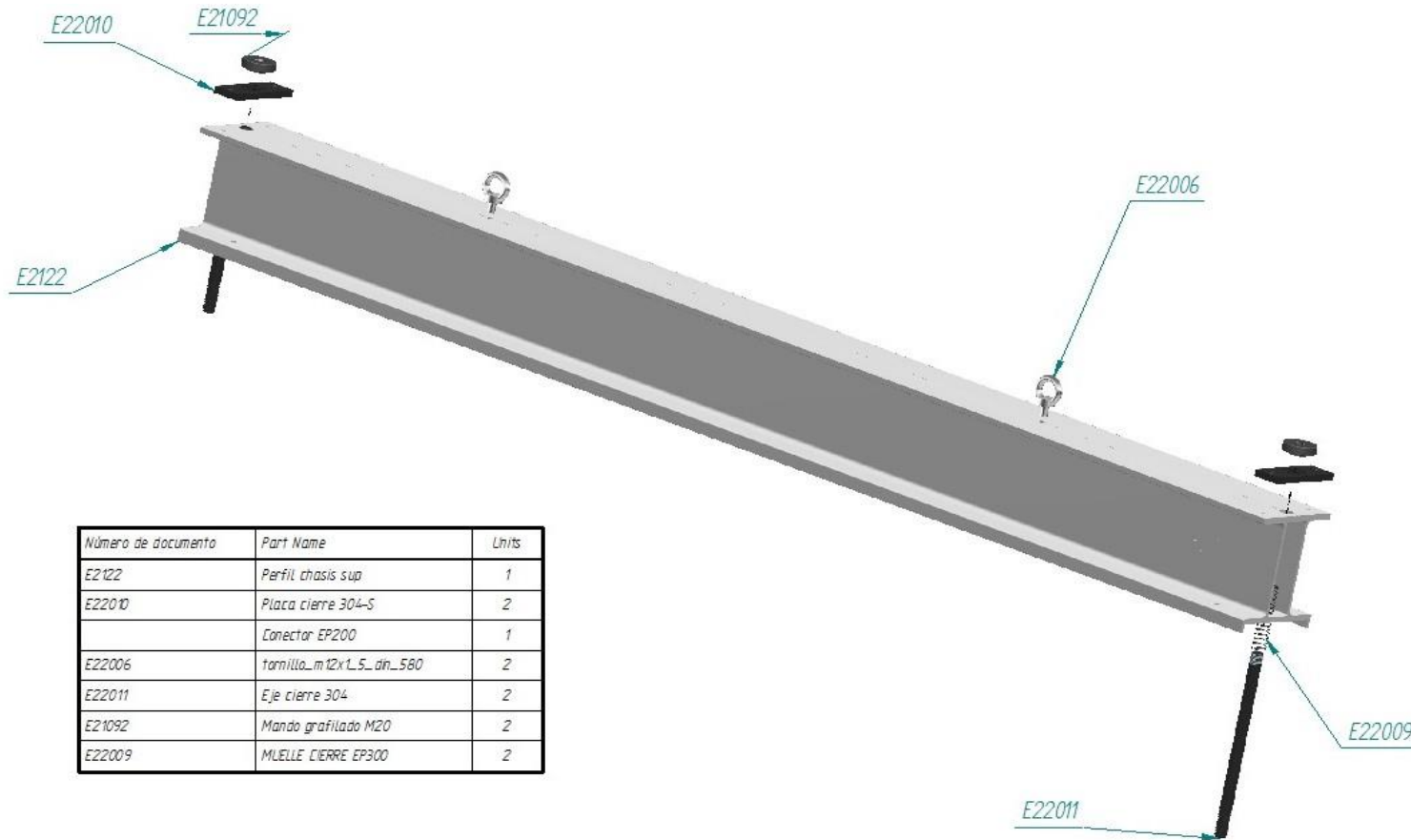

Número de documento	Part Name	Units
E2122	Perfil chasis sup	1
E22010	Placa cierre 304-S	2
	Conector EP200	1
E22006	tornillo_m12x1.5_din_580	2
E22011	Eje cierre 304	2
E21092	Mando grafilado M20	2
E22009	MLELLE LIERRE EP300	2

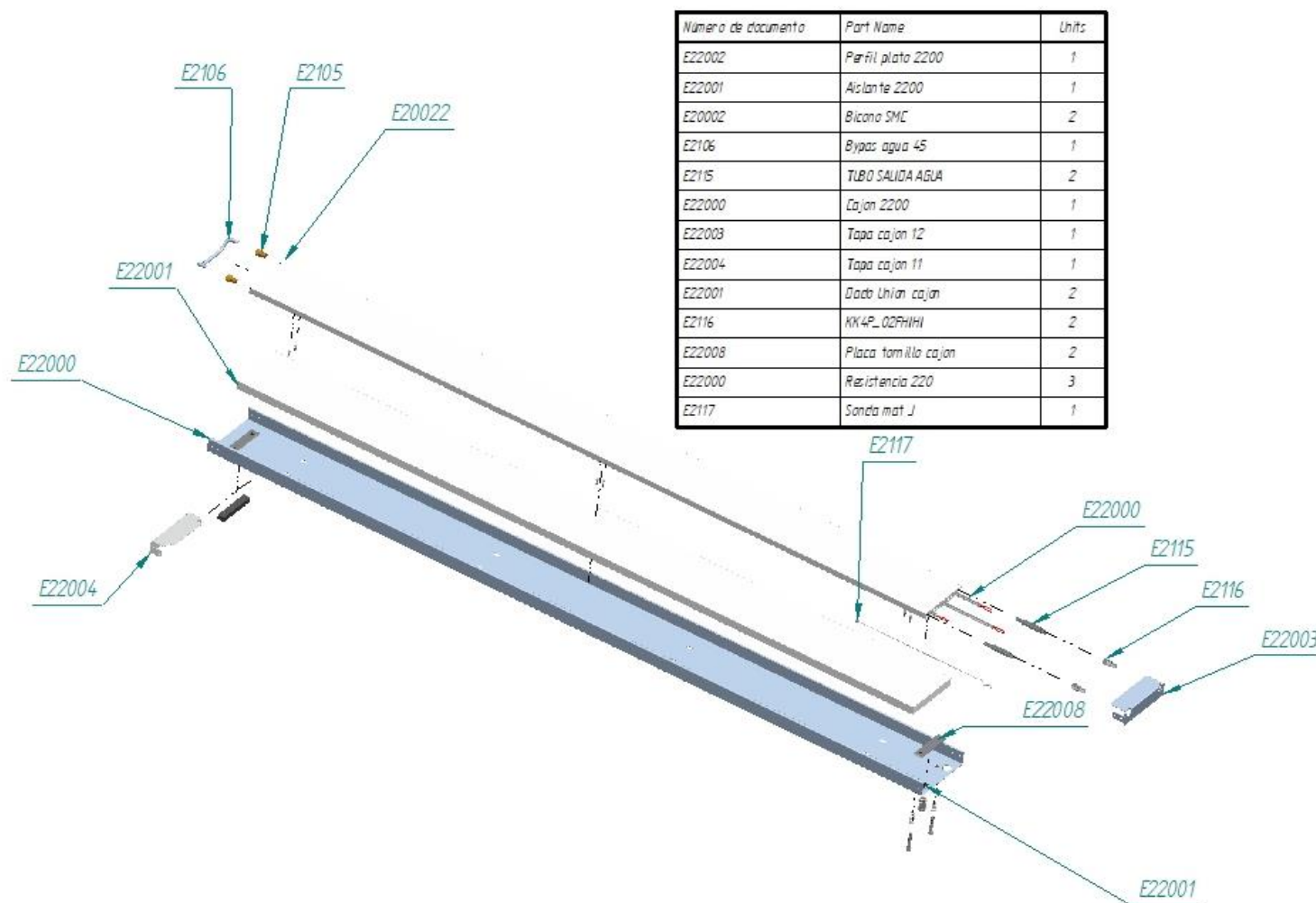

Número de documento	Part Name	Units
E22002	Perfil plato 2200	1
E22001	Aislante 2200	1
E20002	Bicono SME	2
E2106	Bypass agua 45	1
E2115	TUBO SALIDA AGUA	2
E22000	Cajon 2200	1
E22003	Tapa cajon 12	1
E22004	Tapa cajon 11	1
E22001	Diado Union cajon	2
E2116	KK4P_02PHIH	2
E22008	Placa tornillo cajon	2
E22000	Resistencia 220	3
E2117	Sonda mat J	1

Número de documento	Part Name	Units
E2120	Perfil chasis inf	1
E32007	Placa cierre 304-l	2
E32009	Tuerca cierre 304	1
E3149	Bolt_0 IN_93 L_M20x160_v10.50	1

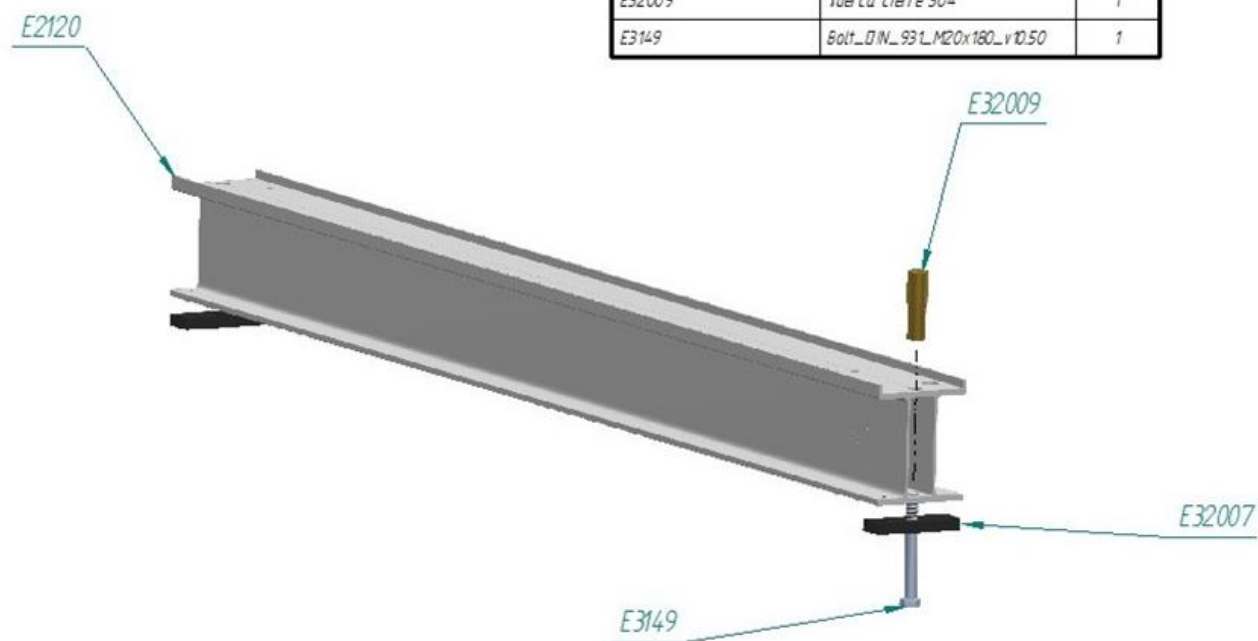

Numb.	Part name	Units
2101	Bandeja 2200	1
2102	Tubo inferior pisador	2
2103	Barra pisador	2
2104	Silic inferior 200	1
2105	Fleje 200	1
2106	gn_ 524_m 10_ 120	4
2107	din_ 466_m 10	4
2108	Screw_DIN_ 912_M10x55_v 950	4
2109	Nut_DIN_ 982_M10_v 950	4

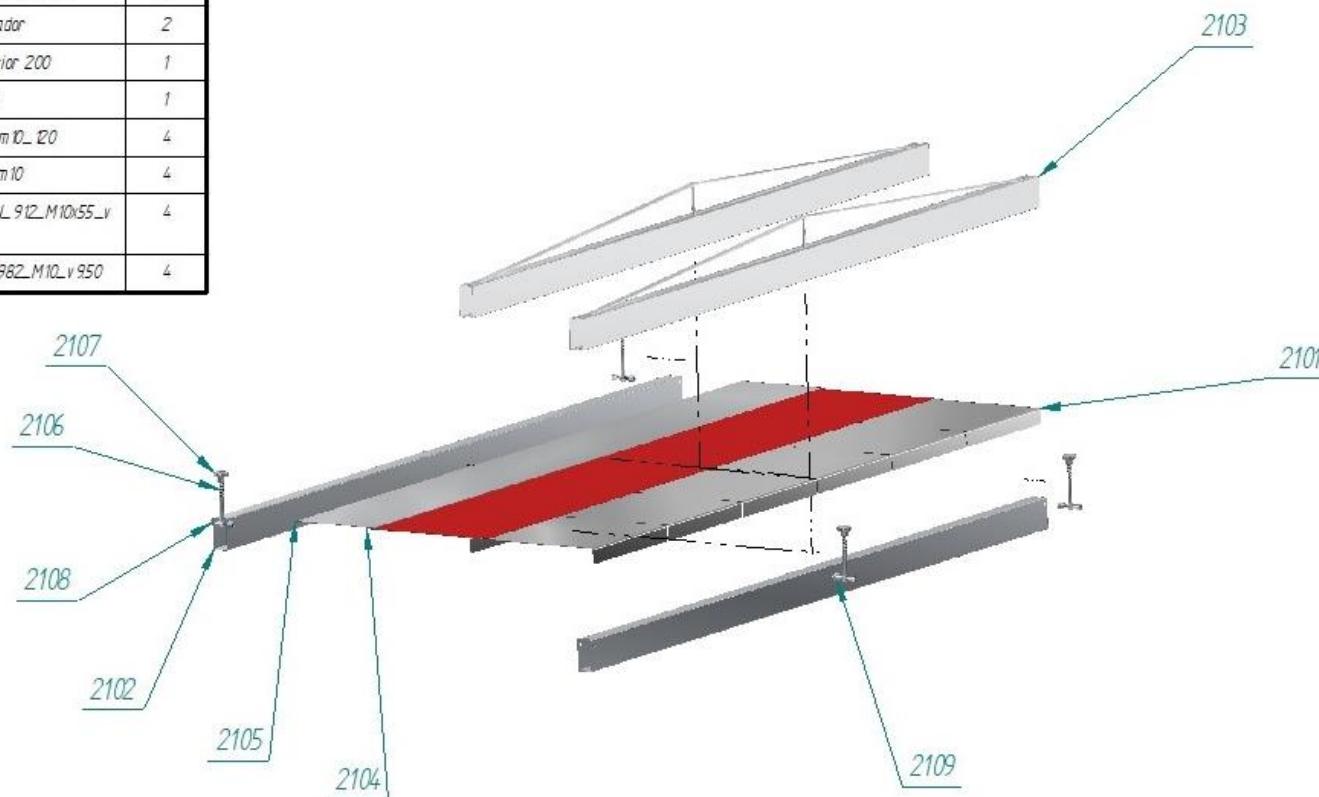

Número de documento	Part Name	Units
E20003	Cajin EP 220	1
E1003	RX4	1
E1002	MANOMETRO	1
E1022	TUBO SALIDA AGUA AB	1
E1004	VALVULA SEGURIDAD	1
E1008	Mangon 1/4	1
E1005	3109_06_13	1
E1004	RECTLS 21MADHO	1

